



# Flat roof access

## Available versions :

- Ready to fix element (according to German standard DIN 4570)
- Upper cover with double seal (according to German standard for energy saving)
- With heating inside the upper cover
- 30 min. and 90 min. fire resistant trapdoors below
- With electric drive below and above
- Concertina stairway to suit a floor to ceiling height of up to 4600 mm



Single seal



Single seal



Double seal



Double seal

### German standard for energy saving (EnEV):

- Larger upper cover to allow the customer to fit 80 - 120 mm of insulation on the side of hatchbox / lining protruding above the roof upstand
- The larger upper cover allows a side insulation from the upstand with an appropriate thickness of insulation material

Thickness of insulation ( mm )	U - value W / m <sup>2</sup> K
40 mm	0,68 W / m <sup>2</sup> K
80 mm	0,38 W / m <sup>2</sup> K
100 mm	0,31 W / m <sup>2</sup> K

### COLUMBUS recommends these optional extras:

- Dehumidifier
- Colourless varnish for wooden hatchboxes

Cross section of flat roof access ( wooden - and steel hatchbox) according to German standard EnEV:

#### Wooden hatchbox

Scheme U - value 0,38 W / m<sup>2</sup> K

#### Steel hatchbox

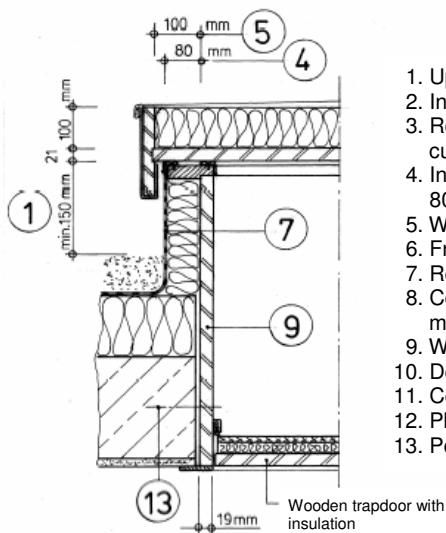

1. Upstand min. 150 mm
2. Insulation made by customer
3. Roofing felt or sheet metal made by customer
4. Insulation made by customer max. 80 mm
5. Wider cover
6. Frame for double seal
7. Roofing felt or sheet metal
8. Cover made of zinc coated sheet metal
9. Wooden hatchbox
10. Double seal
11. Ceiling
12. Plaster work
13. Position of screws to fit

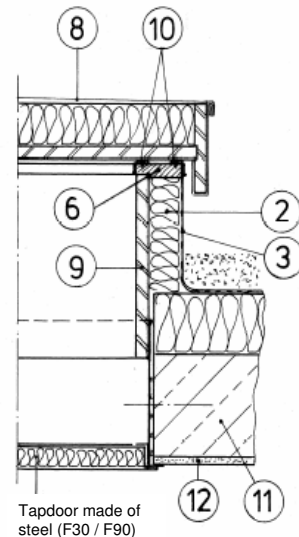

Fixing possible from above and below

Fixing only possible from below

### New - upper cover with electrical heating system:

- Electrical heating system against snow and ice on the upper cover
- Automatic or thermostatic operation possible
- Heating adjustment between + 5 ° C and + 40 ° C
- Specific power ca. 160 W / m<sup>2</sup>
- The average size of the upper cover is appr. 2 m<sup>2</sup>

“ COLUMBUS opens the way to your flat roof “

(Photo on the right side shows you the cross section of a upper cover with heating / defroster)

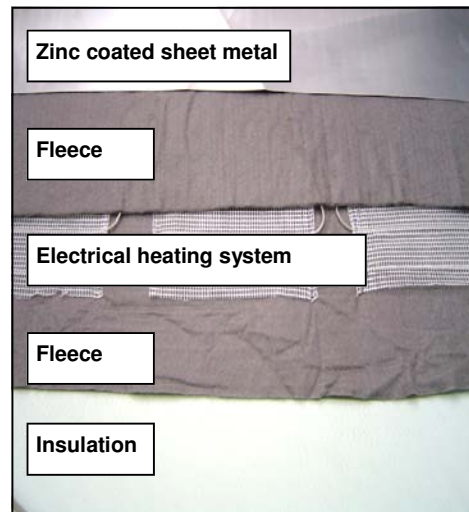

## Options for electrically operated concertina stair and weatherproof roofhatch

- Upper cover electrically operated (please ask us about the minimum dimensions)
- Wind- and rain sensor for upper cover (automatic opening and closing from the upper cover)
- Concertina stair electrically operated (minimum 630 mm opening width for wooden hatchbox, minimum 650 mm opening width for steel casing, 250 mm tread width)
- Infrared remote control for electrically operated concertina ladders
- Smoke warner for electrically operated concertina ladders
- Lockable switch (over and under plasterwork possible)



F30 / F90 steel casing with concertina stair



Wooden casing with concertina stair



Infrared remote control



Door handle with cylinder lock

### Option - Locks for cover below and above

- Cylinder lock for wooden casings and steel casings, key fixed on the pole (cover below)
- Cover ready prepared to fit own cylinder lock
- Door handle with cylinder lock for upper cover - only for flatroof exits (for flat roof exits with option double seal you will need a special cylinder lock)

### Various options:

- Weatherproofed roof hatch for flatroof exit in copper, stainless steel (V2A), aluminium or titan zinc instead of zinc coated steel sheet (please ask us for Uginox or any other sheet metal)
- Device for top opening with cable pull
- Guard rail inside the hatchbox for greater safety when climbing up inside the hatchbox
- Protruding hinges and a longer snap lock (should you want to fix wooden panels or plaster boards onto the trapdoor for - up to a maximum 10 kg weight per m<sup>2</sup>) Please note that is not possible to do this on F30 and F90 fire resistant trapdoors
- Powder coating for concertina stair in RAL colours (only scissor parts, treads and side arms)
- Hatchbox in our exclusiv finish, ready prepared with different veneers and varnish, cover strips made of massiv wood. Please note that is not possible to do this on F30 and F90 fire resistant trapdoors
- Trapdoor with special seal against dust (only for F30 and F90 steel casings)

### Description:

Ready to fix element (according to German standard DIN 4570). Hatchbox made of 19 mm plywood, F30 and F90 fire resistant steel casings made of 1,5 mm steel sheet. Lower cover with insulation.

**Upper cover**, insulated and weatherproofed cover, clad with a zinc coated 1,5 mm steel sheet.

**With concertina stairway** manufactured from die-cast aluminium alloy. Upper cover manually operated (upper cover and trapdoor below both operated manually independent of each other) or automatically operated (upper cover and trapdoor below open and close at the same time). Floor to ceiling height up to 4600 mm possible (subject to a suitable clear opening length and width).

3 - part wooden folding stair as alternative possible (ceiling height subject to a suitable clear opening length and width).

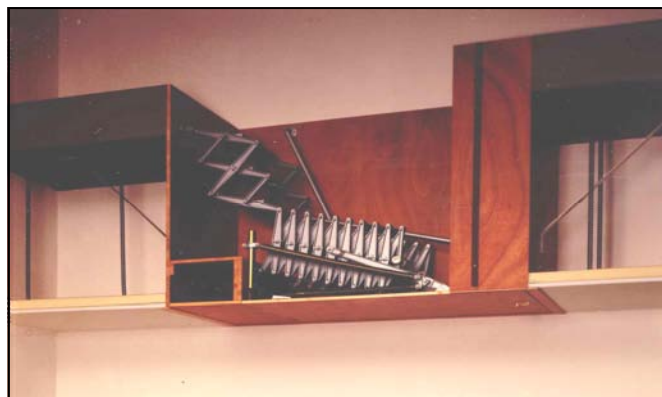

Fixing situation in suspended ceiling construction: concertina stairway manufactured from high strength die-cast aluminium alloy and 3 additional treads fitted above the main stairway at a similar angle to the ladder. This is achieved by forming a step within the lining and therefore having a reduced trapdoor length (the picture shows a unit without an upper cover or upstand).

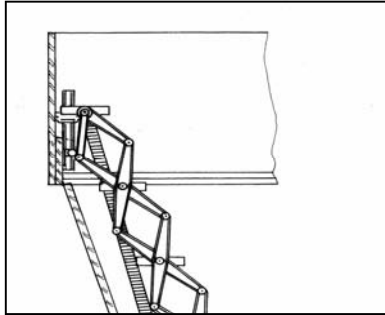

**Scheme A:** standard trapdoor with one additional tread fixed to the lining.

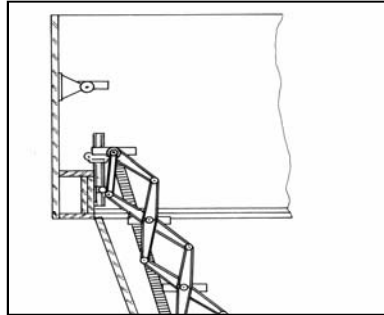

**Scheme B:** shows two treads fitted above the stairway. A step is formed within the lining and a reduced trapdoor length (110 mm) to create an angle similar to the main stairway.

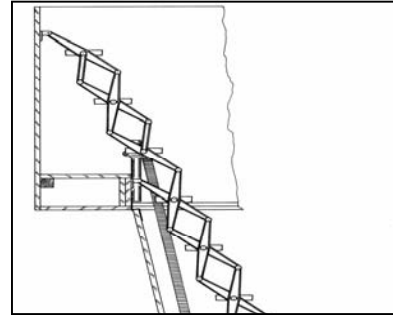

**Scheme C:** shows three additional treads formed as part of the main stairway. A larger step would be formed within the lining and a reduced trapdoor length (370 mm).

**Opening sizes for COLUMBUS flat roof access (manually operated):**

Recommendable opening sizes for flatroof exits with concertina ladders according to German standard DIN 4570

Height floor to ceiling	Lining depth	Opening size Length x width
up to 3690 mm	up to 470 mm	1400 x 700 mm
up to 3090 mm	up to 700 mm	1400 x 700 mm
up to 3690 mm	up to 700 mm	1500 x 700 mm
up to 4300 mm	up to 700 mm	1650 x 700 mm

Please contact us with your measurements



**Telescopic handrail** (1 telescopic handrail included)

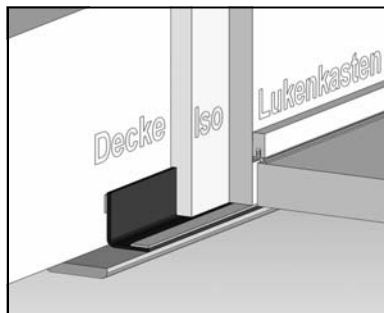

**Connection between hatchbox and building** (option only for flatroof exits with wooden hatchbox)



**Fixing set** - for fixing from COLUMBUS flatroof exits and concertina stairs

Premier Loft Ladders  
 2 Dawson Drive  
 Trimley St Mary,  
 Felixstowe  
 GB - Suffolk IP11 OYW  
 Phone: 0044 / (0) 845 9000 195  
 Fax: 0044 / (0) 1394 214413  
 Mail: [sales@premierloftladders.co.uk](mailto:sales@premierloftladders.co.uk)  
[www.premierloftladders.co.uk](http://www.premierloftladders.co.uk)